

The Benefits of Using Digital Power Modules

Introduction

Digital power is one of the most important technologies for reducing power consumption and managing the growing power complexity in modern electronic systems. From smart handhelds to data servers and wireless base stations, digital power management and control provide real-time intelligence that enables developers to build power systems that automatically adapt to their environment and optimize efficiency. The use of intelligent digital power means automatic compensation for changes in load and system temperature, enabling energy savings with adaptive dead-time control, dynamic voltage scaling for optimal system performance and safe operation with robust protection under various fault conditions.

Power module ICs integrate the PWM controller, inductor, power MOSFETs and passive components into one small package for high-efficiency power conversion. With only a few input and output caps needed to build a complete power supply, power module ICs make the design of power supply simple and easy. By using power modules to power various rails with less PCB area, system designers can develop more compact electronic products with small form factors or add more features to the products with the same size. Faster time to market for new product development can also be achieved as system designers free themselves from complex power supply design and focus on implementing critical features related to product value.

Digital power module ICs provide the benefits of both digital power and power modules, and support the growing industry trend toward high-efficiency power conversion because of their flexibility, high integration and high reliability. This paper explores the many benefits for system designers working with digital power modules, and shows how digital power modules can simplify the design of a high performance compact power supply. The evolution of digital power technology is also discussed, with a focus on new digital control schemes that achieve superior transient performance with less output caps.

The Benefits of Digital Power

Increasingly complex yet reliable power distribution systems such as data servers, network equipment and base stations often need many voltage rails, which are required to sequence or track other rails to properly bias microprocessors, microcontrollers (MCUs), ASICs, FPGAs and any other digital logic ICs that are present in the system. To maximize the performance of these systems under various operating conditions and reduce the overall power consumption, varying the voltages and controlling the operation mode of power converters becomes a basic requirement. Digitally managing the power conversion and power delivery sequencing also becomes essential for any high performance system. Digital power is the industry direction for datacom and telecom infrastructures, and has the following benefits:

- **Enables intelligent power management to maximize system performance**

Digital power ICs communicate with each other via the System Management Bus (SMBus) using the Power Management Bus (PMBus) protocol, the standard protocol for communicating with power conversion systems using a digital communications bus. Using SMBus and PMBus-enabled devices for power conversion provides flexibility and control that is not possible with traditional analog power systems. By designing with digital power, the adjustment of output voltages, power sequencing and synchronization of multiple voltage rails can be easily managed through a host controller (Figure 1) via an I²C communication bus based on PMBus protocol.

In addition, for system monitoring, a digital power solution provides multiple methods of reacting to a fault. Over-current and under-current, over-voltage and under-voltage, and over-temperature faults and warning

thresholds can be configured and adjusted throughout the lifecycle of the product. Operating temperatures can be monitored to regulate the cooling fans dynamically to lower the system power consumption.

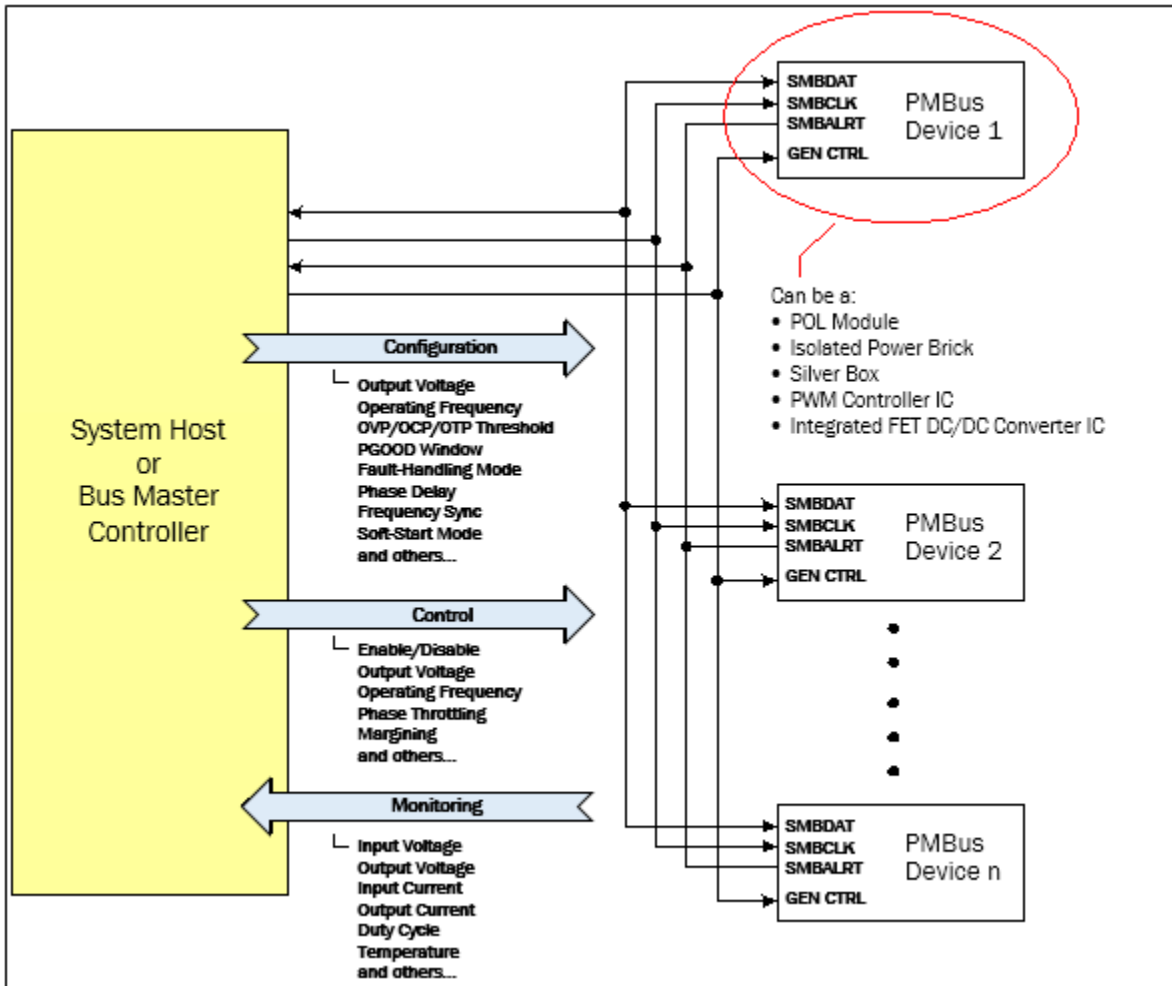

Figure 1. Digital Power Control System via I²C SMBus with PMBus Protocol

- **Reduces development time of system products**

As a product design moves through various phases, changes in the design can occur including the addition of a power rail, more current on a rail or the requirement for a tighter transient response. Normally this would require the redesign of the power distribution system, but with digital power, a new voltage rail can be easily added to the power management system using the industry-standard SMBus. Adding a new rail is integrated into the monitoring, sequencing, margining and fault detection schemes. The digital power IC for the new rail is provided with its own SMBus address. There is no need to reprogram or add more standalone power management ICs because of the additional voltage rail.

Digital power allows system designers to reduce their time on power supply design and concentrate on designing key features and functions for system products, reducing product development time and R&D cost. The chance to win new business also increases thanks to faster time to market for new products.

- **Reduces system BOM costs while improving reliability and product lifespan**

With digital power, many system management and power control functions can be implemented with firmware instead of using extra analog and power control devices. System designers can use the same device for each voltage rail and make changes to the operation of the device without having to make costly hardware changes. As a result, the total BOM cost can be reduced. With fewer components and comprehensive, digitally managed protection features, system products can enjoy greater reliability and a longer lifespan.

- **Enables compact system design and product upgrade within the same chassis**

The increasing demand for high-speed data, voice and video communication has driven datacom and telecom service providers to upgrade their network equipment with faster and more reliable products with more features. While the speed and system functions are increased, the available space is limited. This means that system designer needs to add more function circuits to the board and reduce the area occupied by power supplies. With digital power, many power monitoring and sequencing control functions can be easily implemented with firmware. As a result, PCB area for power supply is reduced and more functional ICs can be added to the same board area.

The Evolution of Digital Power

The definition of digital power varies depending on which silicon or power conversion vendor you ask. Some say it is an analog-based control loop with a digital interface that has added digital power functionality via the PMBus; others insist that digital power is a fully digital control loop in an MCU or digital signal processor (DSP) solution. The first one is called a digital wrapper solution as the analog power control core is wrapped by the digital management circuit. The latter is called a full digital solution with the inherent implication that the user may need to do a significant amount of software coding.

These two digital power solutions have their own pros and cons. The digital wrapper-based solution does not require programming to control the power conversion, but does not offer the full benefits of digital power. It also requires compensation loop design, which can be a challenge for system designers who are not power experts. The full digital power solution has the most flexibility in a closed-loop control scheme, but requires good control algorithms and firmware design. In addition, to achieve high system accuracy, high resolution A/D circuit and faster clock are needed, which can increase the IC cost. Traditionally, the full digital power solution has been implemented with general purpose MCUs or DSPs; however, since MCUs and DSPs are not specifically designed for power supplies, excessive coding and firmware design time are often needed, making it difficult to design full digital power solutions. As a result, the adoption of digital power has been slower than it should be.

For nearly a decade, Intersil has been developing and improving simple, easy-to-use digital power products. The first Intersil digital power device was launched in 2005 by Zilker Labs, which was acquired by Intersil in early 2009. The ZL2005 was the industry's first fully digital controller with PMBus interface. It integrated a traditional digital proportional integral derivative (PID) control loop along with a compact and efficient buck controller, high current adaptive drivers and full power and thermal management functions in a single package. The device provided sequencing, telemetry read back and basic control of the device. However, the PMBus interface could be fairly slow and did not allow for truly accurate sequencing due to delay times.

The second generation device, launched in 2008, added Zilker Labs' patented Digital-DC™ (DDC) technology, a proprietary single-wire interface to overcome the limitations of the previous generation. Next, the third generation controller delivered significantly better digital control, fully leveraging the digital capabilities of the device to make a better power supply. One of the biggest challenges in reducing design complexity in power systems is compensation, and the third generation used auto-compensation to deliver self-stability.

In 2013, Intersil launched the ZL8800 dual output and dual phase digital controller, which represents the fourth generation of Intersil’s digital power platform and is now significantly surpassing the capabilities of analog control. A key problem with analog is that engineers have to work within the poles and zeros of the frequency domain to maintain device stability. The ZL8800 offers a fully digital compensation-free control loop—if an event occurs in a system and the output capacitance changes dynamically, the device will still remain stable, while delivering a faster transient response than is achievable with an analog control loop. This advanced compensation loop technology, coupled with state-of-the-art silicon power IC design and an intuitive easy-to-use GUI-based software (PowerNavigator™), has made it easy to design a high performance fully digital power supply.

ChargeMode™ control is the company’s proprietary digital modulation technology used in its fourth generation digital power products. With this technology, Intersil’s digital power products can meet the following three key requirements of digital power for modern datacom and telecom infrastructures:

1. High bandwidth

ChargeMode control is a digital voltage mode control with the ability to achieve high bandwidth using the single cycle response digital compensator (ASCR) (Figure 2). With the ASCR compensator, the control loop will react to a voltage deviation in a single cycle.

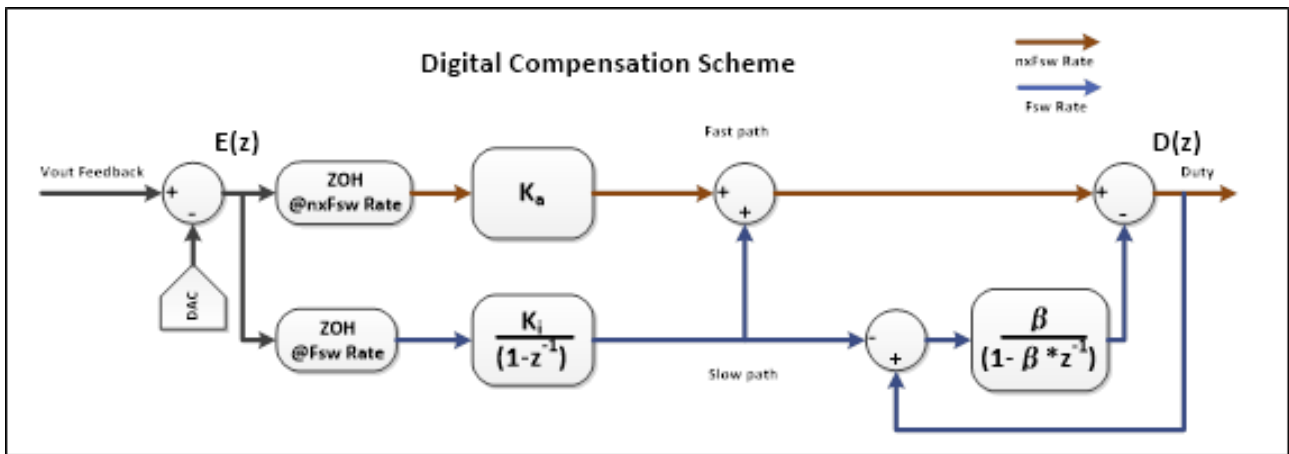

Figure 2. ASCR Digital Compensation Scheme with ChargeMode Control

The compensator block diagram shown in Figure 2 has two parallel paths for processing the quantized error voltage. One is called the “fast path,” which samples error voltage more frequently than the “slow path.” In this unique compensator structure, the duty cycle command is fed back to determine the effect of the fast path and to nullify the fast path effect in the following cycles.

The fast path consists of the proportional gain (ASCR gain) K_a , which samples the error and processes the duty cycle at $n \times F_{sw}$ (n times the switching frequency rate). The slow path samples error at F_{sw} rate and processes duty cycle only once per switching cycle. The fast path responds to voltage deviation in proportion to the error voltage. The slow path consists of the integrator function with K_i as its gain used for low frequency gain and duty cycle reset function with β as its gain. The duty cycle reset function nullifies the effect of the fast path during a transient event as it feeds back the duty cycle change due to fast path and also the steady state duty cycle from the integral function. The compensator simplifies down to a two-pole, two-zero filter, which enables the stability of the closed-loop system.

ChargeMode control with ASCR digital compensator reduces the delays between the error sampling instant and the duty cycle decision. This translates to a natural phase boost at high frequencies, which brings stability and makes it possible for high-bandwidth designs (Figure 3).

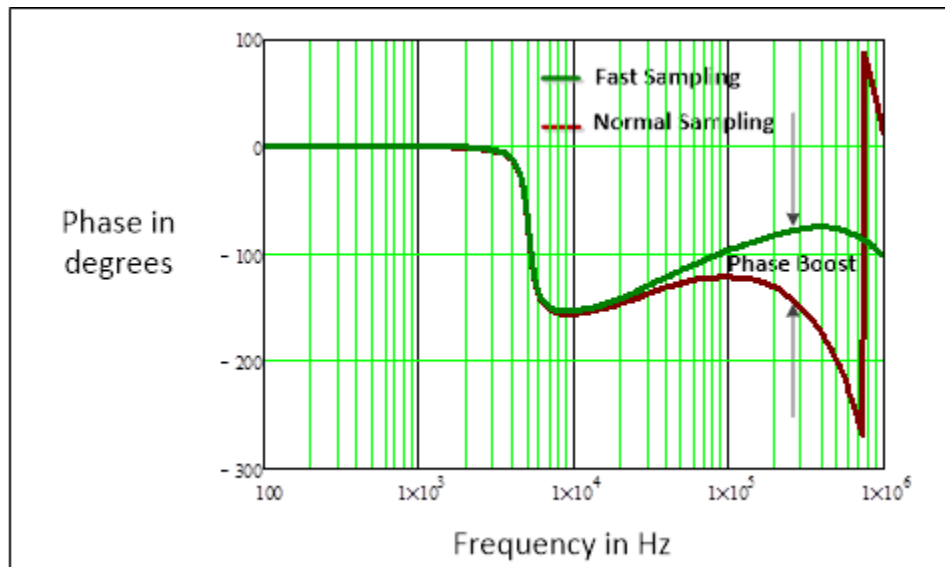

Figure 3. The Phase Boost Effect of ChargeMode Control with ASCR Digital Compensator

2. Compensation-free

The ASCR compensator can achieve an inherently stable control loop, which only needs to be tuned for bandwidth specification. In a wide range of output filter configurations, only ASCR gain needs to be varied to reach the desired closed-loop bandwidth operation. In fact, there are two inputs to the ASCR block: gain setting and a residual. Gain sets up the overall transient response speed, whereas the residual is a dampening factor, essentially setting the response rate of the loop, which could be important to generate the last ounce of performance. However, the ZL8800 default setting for the residual value is suitable for most systems.

3. Support fixed frequency switching

Traditionally, voltage or current mode hysteretic controllers have offered the best loop response, but these come with the drawback of switching with variable frequencies during transient. With ChargeMode control, the switching frequency is fixed to ensure tight control of the noise spectrum in end-user applications.

The Benefits of Power Module ICs

Integrating PWM control, power stage, inductor and passive components into a small package is another industry trend for power supplies in industrial, infrastructure and high end consumer applications. This kind of system on chip power product is called a power module IC. Figure 4 shows the structure of a power module and its application circuit. With only a few input and output caps needed, the design of power supply is easy with power module ICs.

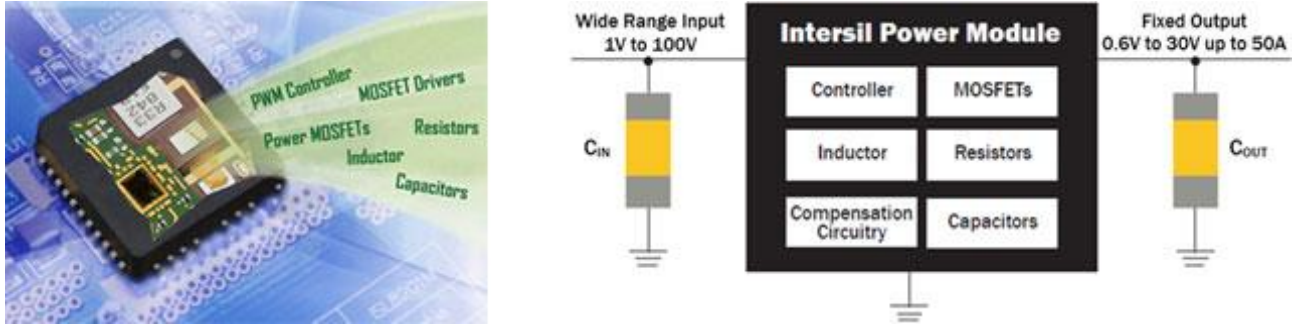

Figure 4. Power Module IC and its Application Circuit

Power module ICs offer the following benefits to system designers:

- **High efficiency power conversion**

To ensure a small form factor and maximize the output power capability, the internal components and switching frequency are carefully selected to achieve high efficiency. In addition, the power loss due to connection resistance and other parasitic parameters are also significantly reduced. Thus, power module ICs often have higher efficiency than discrete power modules at the same power level.

- **Small PCB area and the option to use bottom layer for power supply**

With only a few input and output caps required, the power module takes less space for a complete power supply. Due to its low profile, the power module can be mounted at the backside of the board to free up the top space for function chips.

- **No heat sink**

With a well-designed thermally enhanced lead frame package, power modules have excellent thermal performance. The heat generated by internal power devices and inductors can be transferred efficiently to the outside via bottom PCB and top surface. Oftentimes, a heat sink is not needed.

- **High reliability**

The development and manufacturing of power module ICs use a similar process as standard IC products. Reliability tests such as HTOL, temperature cycling, vibration, thermal shock and electrical stress tests are part of the qualification tests. With strict quality control, the power module-based power supply has much less chance to fail in the field.

- **Cost saving for new product development**

With power module ICs, system designers can complete the design of power supply systems for their products in a much shorter timeframe and spend more time on higher level system design work. This helps designers reduce the product development cycle, R&D costs and time to market for new products.

ISL8270M/71M: The Industry's Most Advanced 25/33A Digital Power Module ICs

PMBus-enabled digital power module ICs have all the benefits of both digital power and power modules. To maximize the key benefits of digital power and make the design of smart power supply easy, Intersil offers two high-density digital power products: ISL8270M and ISL8271M. The devices can convert 4.5V-14V input voltage source to 0.6V-5V output with output current up to 25/33A respectively and up to 96% efficiency.

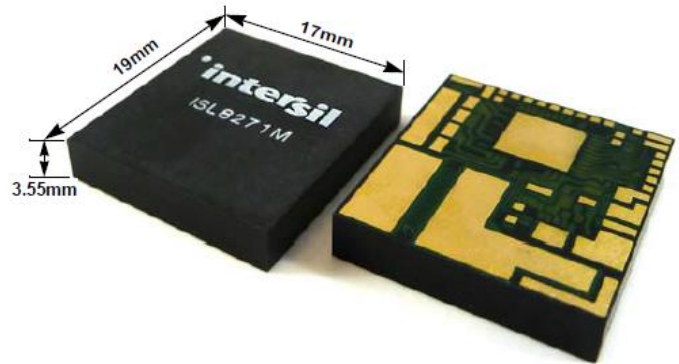
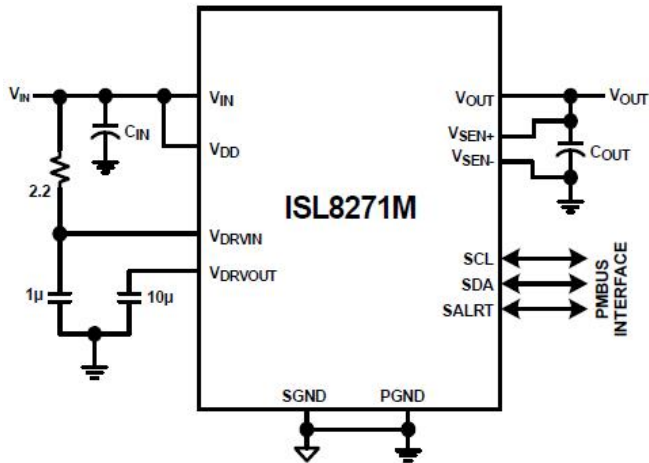
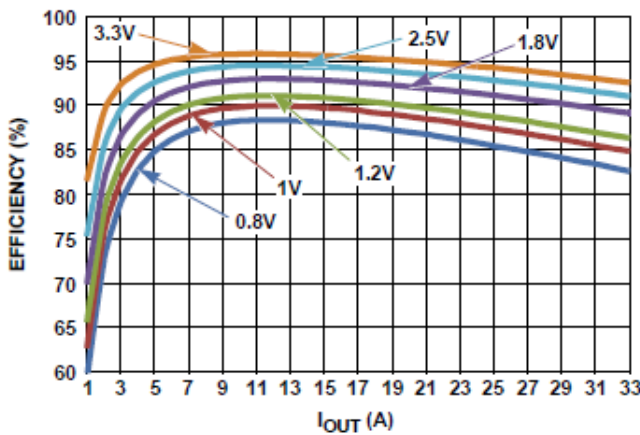
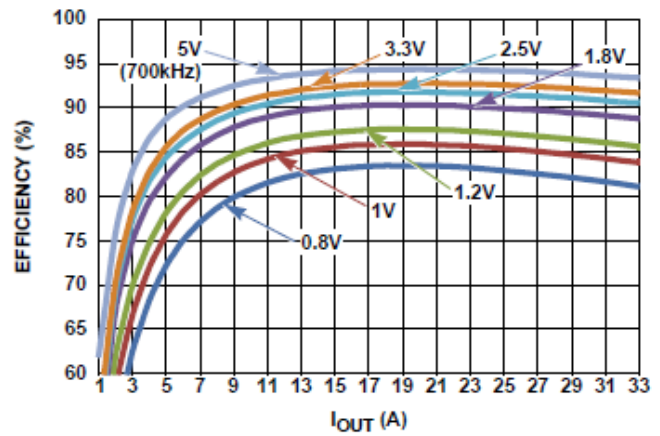

Figure 5. Application Circuit of ISL8271M and its Package

As shown in Figure 5, the application circuit of ISL8271M is very simple—only a few input and output caps are needed to design a complete high density digital power supply. The module has very high efficiency over the entire operation range (Figure 6).



a. 5V_{IN}



b. 12V_{IN}

Figure 6. Efficiency of ISL8271M at 533kHz Switching Frequency under Various Output Voltage/Current Conditions

With Intersil's latest propriety ChargeMode control technology and ASCR digital compensator, the ISL8270M and ISL8271 digital power modules can achieve optimal transient performance to power high speed ASICs and processors (Figure 7).

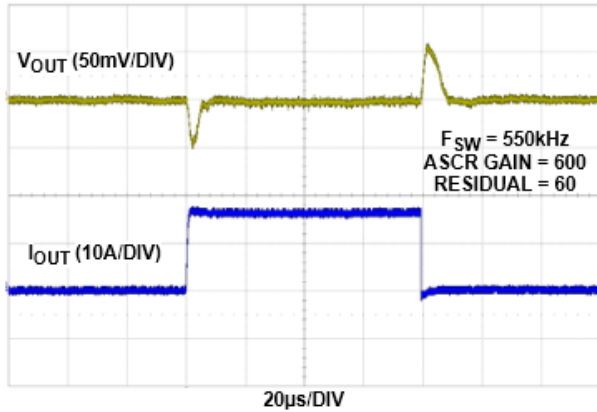

a. With High Bandwidth ASCR Parameters

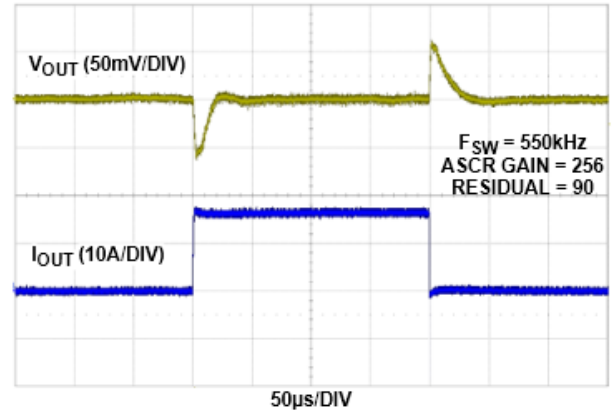

b. With Default ASCR Parameters

Figure 7. Transient Performance of ISL8271M with $C_{OUT} = 4 \times 100\mu\text{F}$ Ceramic and $2 \times 470\mu\text{F}$ POSCAP

To ensure reliability and excellent thermal performance, the ISL8270M and ISL8271M modules use Intersil's patented thermally enhanced HDA package. The junction to case thermal resistance is only 7.5C/w. As shown in Figure 8, the ISL8270M and ISL8271M can output rated current for 12VIN to 1VOUT power conversion at high temperature.

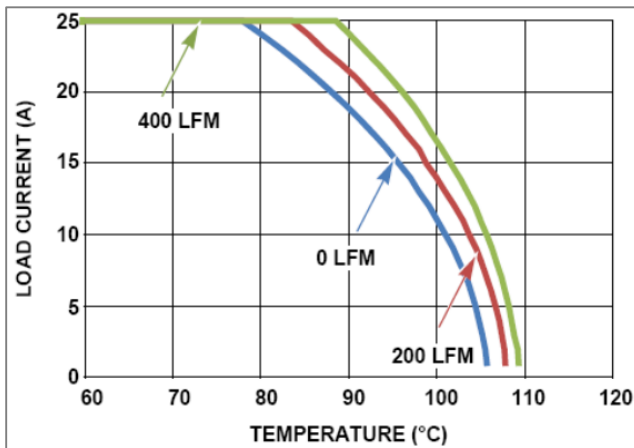

a. ISL8270M

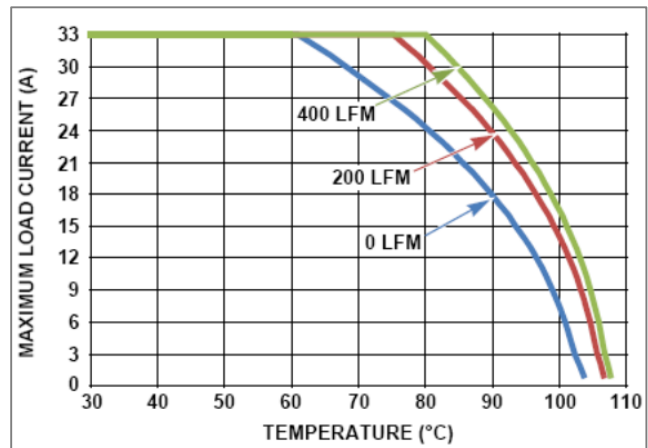

b. ISL8271M

Figure 8. Output Current Thermal Derating Curves of ISL8270M and ISL8271M at 12VIN/1VOUT

Conclusion

PMBus-enabled digital power module ICs make the design of high efficiency, compact and intelligent power supply easy. By using digital power modules, system designers can save PCB space for more function circuit, reduce their product development time, reduce R&D costs and quickly deliver new products to market. With digital control and high reliability, system operation can be optimized for low power consumption and longer lifespan. Intersil's ISL8270M (25A) and ISL8271M (33A) products are perfect examples of easy-to-use, high performance digital power modules. With proprietary ChargeMode control technology and ASCR digital compensator, optimized power stage components and a patented thermally enhanced HDA package, the ISL8270M and ISL8271M modules offer excellent transient performance with few output caps and up to

96% power conversion efficiency over a wide V_{IN} and wide V_{OUT} range. They are the ideal products to power ASICs, FPGA, DSP, CPU and memory for computing, communication infrastructure and industrial applications.

Next Steps

- [Find out more about the ISL8270M 25A digital power module](#)
- [Get the ISL8270M datasheet](#)
- [Find out more about the ISL8271M 33A digital power module](#)
- [Get the ISL8271M datasheet](#)
- [Download the PowerNavigator software](#)
- [Learn more about Intersil's power module solutions](#)
- [Search for power module parts using our parametric search](#)

#

About Intersil

Intersil Corporation is a leader in the design and manufacture of high-performance analog, mixed-signal and power management semiconductors for the industrial and infrastructure, personal computing and high-end consumer markets. For more information about Intersil, visit our website at www.intersil.com.

+1 408-432-8888 | ©2014 Intersil Americas LLC. All rights reserved. Intersil (and design) is a trademark owned by Intersil Corporation or one of its subsidiaries. All other trademarks mentioned are the property of their respective owners.