

EL7512

High Frequency PWM Step-Up Regulator

FN7290  
Rev 1.00  
May 23, 2005

The EL7512 is a high frequency, high efficiency step-up DC:DC regulator operated at fixed frequency PWM mode. With an integrated 1A MOSFET, it can deliver up to 600mA output current at up to 90% efficiency. The adjustable switching frequency is up to 1.2MHz, making it ideal for DSL applications.

When shut down, it draws <math>3\mu A</math> of current. This feature, along with the minimum starting voltage of 2V, makes it suitable for portable equipment powered by one lithium ion or 3 to 4 NiMH cells.

The EL7512 is available in a 10-pin MSOP package, with maximum height of 1.1mm. With proper external components, the whole converter takes less than 0.25in<sup>2</sup> PCB space.

This device is specified for operation over the full -40°C to +85°C temperature range.

Pinout

EL7512  
(10-PIN MSOP)  
TOP VIEW

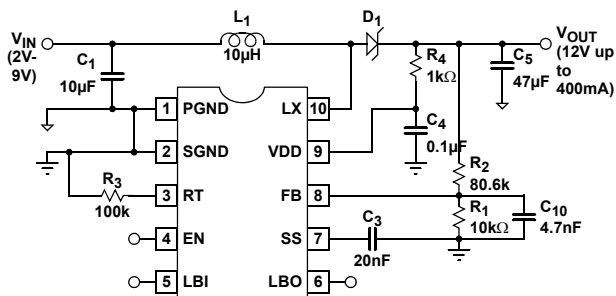

Features

- 90% efficiency
- Up to 600mA I<sub>OUT</sub>
- 5V < V<sub>OUT</sub> < 18V
- V<sub>IN</sub> > 2V
- Up to 1.2MHz adjustable frequency
- < 3µA shutdown current
- Adjustable soft-start
- Low battery detection
- Internal thermal protection
- 1.1mm max height 10-pin MSOP package
- Pb-Free available (RoHS compliant)

Applications

- 3V to 5V, 12V, and 18V converters
- 5V to 12V and 16V converters
- TFT-LCD
- DSL
- Portable equipment
- Desktop equipment

Ordering Information

PART NUMBER	PACKAGE	TAPE & REEL	PKG. DWG. #
EL7512CY	10-Pin MSOP	-	MDP0043
EL7512CY-T7	10-Pin MSOP	7"	MDP0043
EL7512CY-T13	10-Pin MSOP	13"	MDP0043
EL7512CYZ (See Note)	10-Pin MSOP (Pb-free)	-	MDP0043
EL7512CYZ-T7 (See Note)	10-Pin MSOP (Pb-free)	7"	MDP0043
EL7512CYZ-T13 (See Note)	10-Pin MSOP (Pb-free)	13"	MDP0043

NOTE: Intersil Pb-free products employ special Pb-free material sets; molding compounds/die attach materials and 100% matte tin plate termination finish, which are RoHS compliant and compatible with both SnPb and Pb-free soldering operations. Intersil Pb-free products are MSL classified at Pb-free peak reflow temperatures that meet or exceed the Pb-free requirements of IPC/JEDEC J STD-020.

**Absolute Maximum Ratings** ( $T_A = 25^\circ\text{C}$ )

EN, LBI, .....	+18V	Storage Temperature .....	-65°C to +150°C
LX .....	.20V	Operating Temperature .....	-40°C to +85°C
V <sub>DD</sub> .....	.12V	Operating Junction Temperature: .....	135°C

**CAUTION:** Stresses above those listed in "Absolute Maximum Ratings" may cause permanent damage to the device. This is a stress only rating and operation of the device at these or any other conditions above those indicated in the operational sections of this specification is not implied.

**IMPORTANT NOTE:** All parameters having Min/Max specifications are guaranteed. Typical values are for information purposes only. Unless otherwise noted, all tests are at the specified temperature and are pulsed tests, therefore:  $T_J = T_C = T_A$

**Electrical Specifications**  $V_{IN} = 5\text{V}$ ,  $V_{OUT} = 12\text{V}$ ,  $I_{OUT} = 0\text{mA}$ ,  $R_T = 100\text{k}\Omega$ ,  $T_A = 25^\circ\text{C}$  unless otherwise specified.

PARAMETER	DESCRIPTION	CONDITION	MIN	TYP	MAX	UNIT
IQ1	Quiescent Current - Shut-down	VEN = 0			3	$\mu\text{A}$
IQ2	Quiensent Current	VEN = 2V		2.5	4	mA
VFB	Feedback Voltage		1.31	1.35	1.39	V
IB	Feedback Input Bias Current				0.10	$\mu\text{A}$
V <sub>IN</sub>	Input Voltage Range		2			V
D <sub>MAX</sub>	Maximum Duty Cycle		84	90		%
I <sub>LIM</sub>	Current Limit - Max Average Input Current		1000	1250	1500	mA
I <sub>SHDN</sub>	Shut-down Input Bias Current				1	$\mu\text{A}$
V <sub>LBI</sub>	LBI Threshold Voltage		180	220	250	mV
V <sub>OL-LBO</sub>	LBO Output Low	ILBO = 1mA		0.1	0.2	V
I <sub>LEAK-LBO</sub>	LBO Output Leakage Current	VLBI = 250mV, VLBO = 5V		0.02	1	$\mu\text{A}$
R <sub>DS-ON</sub>	Switch On Resistance	at 12V output		300		m $\Omega$
I <sub>LEAK-SWITCH</sub>	Switch Leakage Current				1	$\mu\text{A}$
$\Delta V_{OUT}/\Delta V_{IN}$	Line Regulation	3V < V <sub>IN</sub> < 6V, V <sub>OUT</sub> = 12V, no load			0.15	%/V
$\Delta V_{OUT}/\Delta I_{OUT}$	Load Regulation	I <sub>OUT</sub> < 250mA		0.5		%
F <sub>OSC-MAX</sub>	Maximum Switching Frequency	R <sub>T</sub> = 49.9k $\Omega$		1200		kHz
F <sub>OSC1</sub>	Switching Frequency		530	670	800	kHz
V <sub>HI_EN</sub>	EN Input High Threshold		1.6			V
V <sub>LO_EN</sub>	EN Input Low Threshold				0.5	V

**Pin Descriptions**

PIN NUMBER	PIN NAME	PIN FUNCTION
1	PGND	Power ground; connected to the source of internal N-channel power MOSFET
2	SGND	Signal ground; ground reference for all the control circuitry; needs to have only a single connection to PGND
3	RT	Timing resistor to adjust the oscillation frequency of the converter
4	EN	Chip enable; connects to logic HI (>1.6V) for chip to function
5	LBI	Low battery input; connects to a sensing voltage, or left open if function is not used
6	LBO	Low battery detection output; connected to the open drain of a MOSFET; able to sink 1mA current
7	SS	Soft-start; connects to a capacitor to control the start-up of the converter
8	FB	Voltage feedback input; needs to connect to resistor divider to decide V <sub>O</sub>
9	VDD	Control circuit positive supply
10	LX	Inductor drive pin; connected to the drain of internal N-channel power MOSFET

### Block Diagram

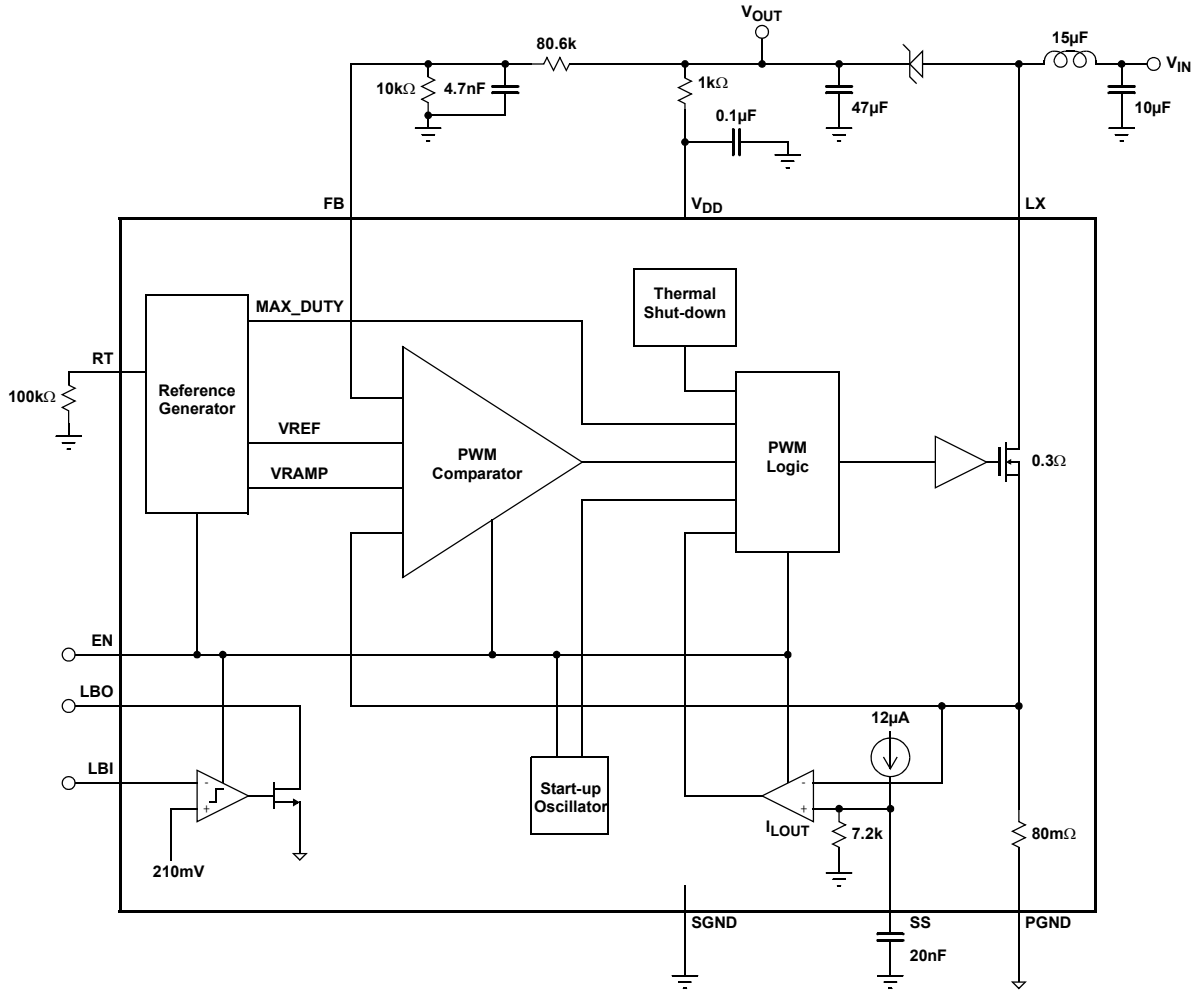

## Typical Performance Curves

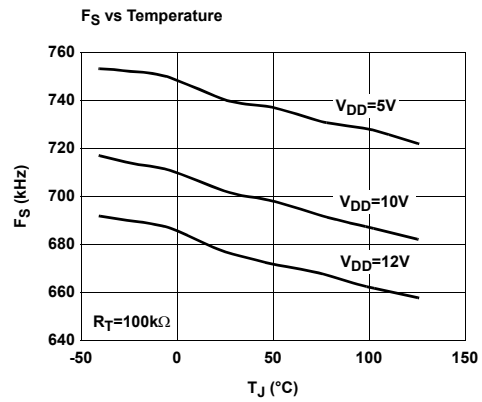
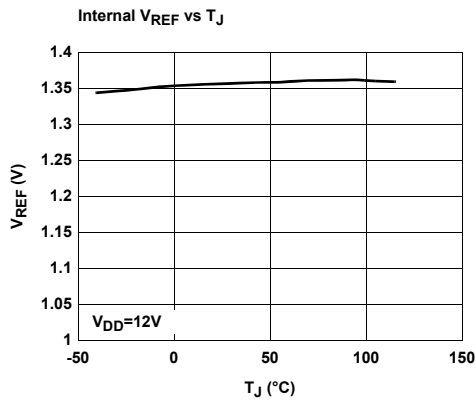
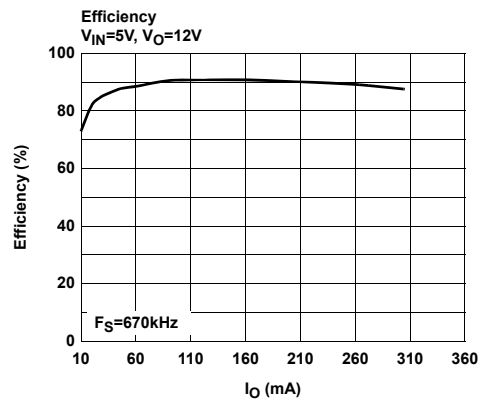
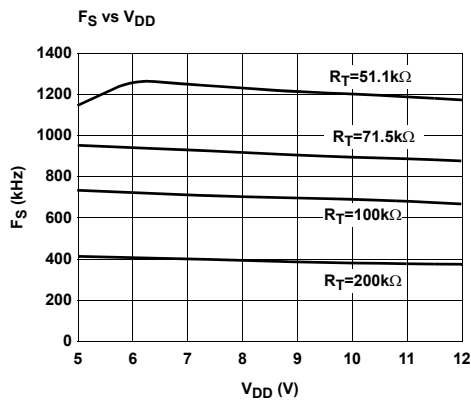
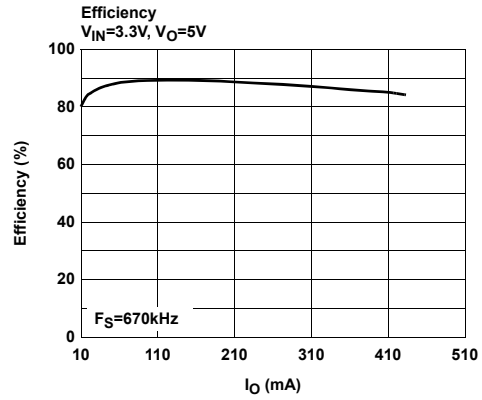
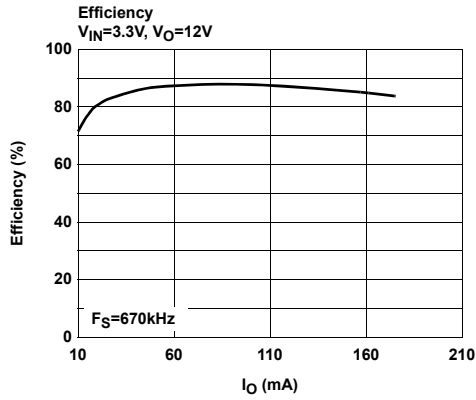

Typical Performance Curves (Continued)

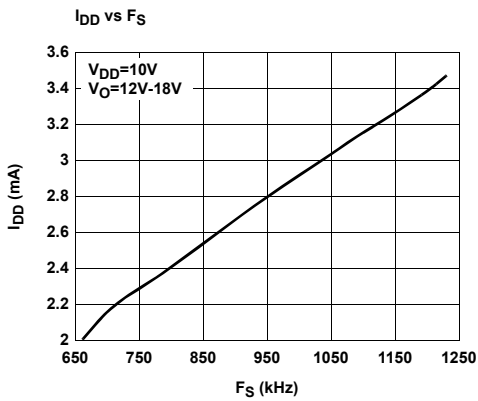
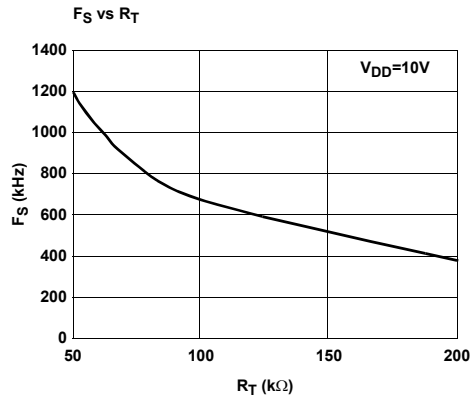
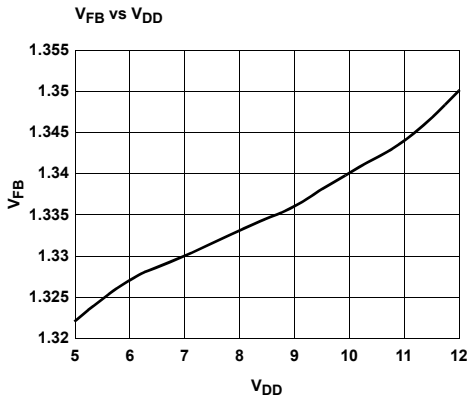

Steady State Operation (inductor continuous conduction) V<sub>IN</sub>=5V, V<sub>O</sub>=12V, I<sub>O</sub>=300mA

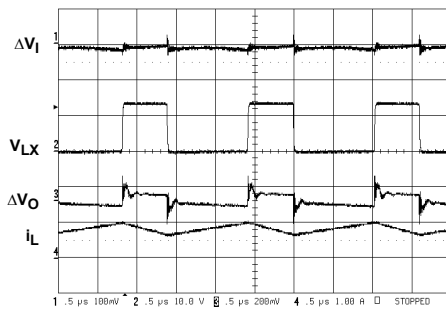

Steady State Operation (inductor discontinuous conduction) V<sub>IN</sub>=5V, V<sub>O</sub>=12V, I<sub>O</sub>=25mA

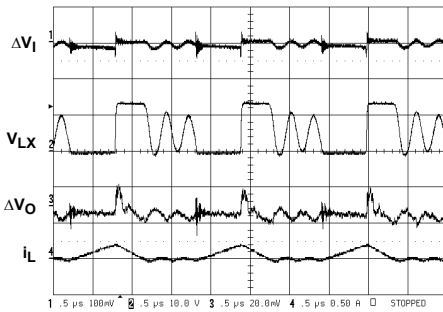

Power-Up V<sub>IN</sub>=5V, V<sub>O</sub>=12V, I<sub>O</sub>=300mA

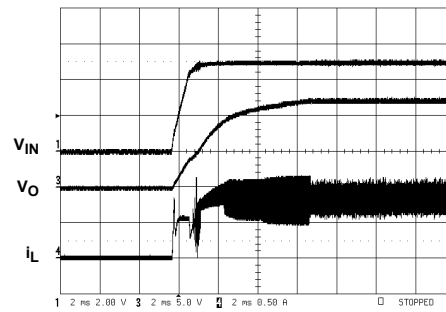

Load Transient Response V<sub>IN</sub>=5V, V<sub>O</sub>=12V, I<sub>O</sub>=50mA-300mA

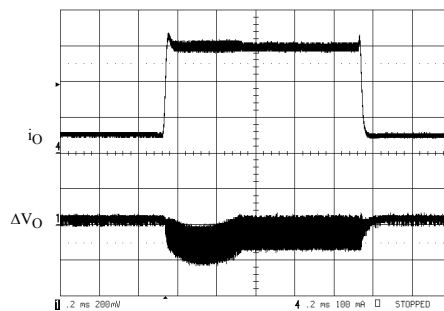

## Applications Information

The EL7512 is a step-up regulator, operated at fixed frequency pulse-width-modulation (PWM) control. The input voltage is 2V-12V and output voltage is 5V-18V. The switching frequency (up to 1.2MHz) is decided by the resistor connected to RT pin.

### Start-Up

After  $V_{DD}$  reaches a threshold of about 2V, the start-up oscillator generates fixed duty-ratio of 0.5-0.7 at a frequency of several hundred kilohertz. This will boost the output voltage.

When  $V_{DD}$  reaches about 3.7V, the PWM comparator takes over the control. The duty ratio will be decided by the multiple-input direct summing comparator, Max\_Duty signal (about 90% duty-ratio), and the Current Limit Comparator, whichever is the smallest.

The soft-start is provided by the current limit comparator. As the internal 12 $\mu$ A current source charges the external CSS, the peak MOSFET current is limited by the voltage on the capacitor. This in turn controls the rising rate of the output voltage.

The regulator goes through the start-up sequence as well after the EN signal is pulled to HI.

### Steady-State Operation

When the output reaches the preset voltage, the regulator operates at steady state. Depending on the input/output conditions and component values, the inductor operates at either continuous-conduction mode or discontinuous-conduction mode.

In the continuous-conduction mode, the inductor current is a triangular waveform and LX voltage a pulse waveform. In the discontinuous-conduction mode, the inductor current is completely dried out before the MOSFET is turned on again. The input voltage source, the inductor, and the MOSFET and output diode parasitic capacitors forms a resonant circuit. Oscillation will occur in this period. This oscillation is normal and will not affect the regulation.

At very low load, the MOSFET will skip pulses sometimes. This is normal.

### Current Limit

The MOSFET current limit is nominally 1.2A and guaranteed 1A. This restricts the maximum output current  $I_{OMAX}$  based on the following formula:

$$I_{OMAX} = \left(1 - \frac{\Delta I_L}{2}\right) \times \frac{V_{IN}}{V_O}$$

where:

$\Delta I_L$  is the inductor peak-to-peak current ripple and is decided by:

$$\Delta I_L = \frac{V_{IN}}{L} \times \frac{D}{F_S}$$

D is the MOSFET turn-on ratio and is decided by:

$$D = \frac{V_O - V_{IN}}{V_O}$$

$F_S$  is the switching frequency.

The following table gives typical values:

MAX CONTINUOUS OUTPUT CURRENTS

$V_{IN}$ (V)	$V_O$ (V)	L ( $\mu$ H)	$F_S$ (kHz)	$I_{OMAX}$ (mA)
2	5	10	1000	360
2	9	10	1000	190
2	12	10	1000	140
3.3	5	10	1000	600
3.3	9	10	1000	310
3.3	12	10	1000	230
5	9	10	1000	470
5	12	10	1000	340
5	15	10	1000	260
9	12	10	1000	630
9	15	10	1000	470
12	15	10	1000	670
12	18	11	1000	510

### Component Considerations

It is recommended that  $C_{IN}$  is larger than 10 $\mu$ F. Theoretically, the input capacitor has ripple current of  $\Delta I_L$ . Due to high-frequency noise in the circuit, the input current ripple may exceed the theoretical value. Larger capacitor will reduce the ripple further.

The inductor has peak and average current decided by:

$$I_{LAVG} = \frac{I_O}{1-D}$$

$$I_{LPK} = I_{LAVG} + \frac{\Delta I_L}{2}$$

The inductor should be chosen to be able to handle this current. Furthermore, due to the fixed internal compensation, it is recommended that maximum inductance of 10 $\mu$ H and 15 $\mu$ H to be used in the 5V and 12V or higher output voltage, respectively.

The output diode has average current of  $I_O$ , and peak current the same as the inductor's peak current. Schottky diode is recommended and it should be able to handle those currents.

Output voltage ripple is the product of peak inductor current times the ESR of output capacitor. Low ESR capacitor is to be used to reduce the output ripple. The minimum output capacitance of 330 $\mu$ F, 47 $\mu$ F, and 33 $\mu$ F is recommended for 5V, 12V, and 16V for 600kHz switching frequency, respectively. For 1MHz switching frequency, 220 $\mu$ F, 33 $\mu$ F, and 22 $\mu$ F capacitor can be used for the output voltages. In addition to the voltage rating, the output capacitor should also be able to handle the rms current is given by:

$$I_{CORMS} = \sqrt{(1-D) \times \left( D + \frac{\Delta I_L^2}{I_{LAVG}^2} \times \frac{1}{12} \right) \times I_{LAVG}}$$

### Output Voltage

An external resistor divider is required to divide the output voltage down to the nominal reference voltage. The current drawn by the resistor network should be limited to maintain the overall converter efficiency. The maximum value of the resistor network is limited by the feedback input bias current and the potential for noise being coupled into the feedback pin. A resistor network less than 300k $\Omega$  is recommended. The boost converter output voltage is determined by the relationship:

$$V_{OUT} = V_{FB} \times \left( 1 + \frac{R_2}{R_1} \right)$$

where  $V_{FB}$  slightly changes with  $V_{DD}$ . The curve is shown in this data sheet.

### RC Filter

The maximum voltage rating for the  $V_{DD}$  pin is 12V and is recommended to be about 10V for maximum efficiency to drive the internal MOSFET. The series resistor R4 in the RC filter connected to  $V_{DD}$  can be utilized to reduce the voltage. If  $V_O$  is larger than 10V, then:

$$R_4 = \frac{V_O - 10}{I_{DD}}$$

where  $I_{DD}$  is shown in  $I_{DD}$  vs  $F_S$  curve. Otherwise, R4 can be 10 $\Omega$  to 51 $\Omega$  with C4 = 0.1 $\mu$ F.

### Thermal Performance

The EL7512 uses a fused-lead package, which has a reduced  $\theta_{JA}$  of 100 $^{\circ}$ C/W on a four-layer board and 115 $^{\circ}$ C/W on a two-layer board. Maximizing copper around the ground pins will improve the thermal performance.

This chip also has internal thermal shut-down set at around 135 $^{\circ}$ C to protect the component.

### Layout Considerations

The layout is very important for the converter to function properly. Power Ground (  $\downarrow$  ) and Signal Ground (  $\frac{\perp}{\text{---}}$  ) should be separated to ensure that the high pulse current in the Power Ground never interferes with the sensitive signals connected to Signal Ground. They should only be connected at one point.

The trace connected to pin 8 (FB) is the most sensitive trace. It needs to be as short as possible and in a "quiet" place, preferably between PGND or SGND traces.

In addition, the bypass capacitor connected to the  $V_{DD}$  pin needs to be as close to the pin as possible.

The heat of the chip is mainly dissipated through the SGND pin. Maximizing the copper area around it is preferable. In addition, a solid ground plane is always helpful for the EMI performance.

The demo board is a good example of layout based on these principles. Please refer to the EL7512 Application Brief for the layout.

**Package Outline Drawing**

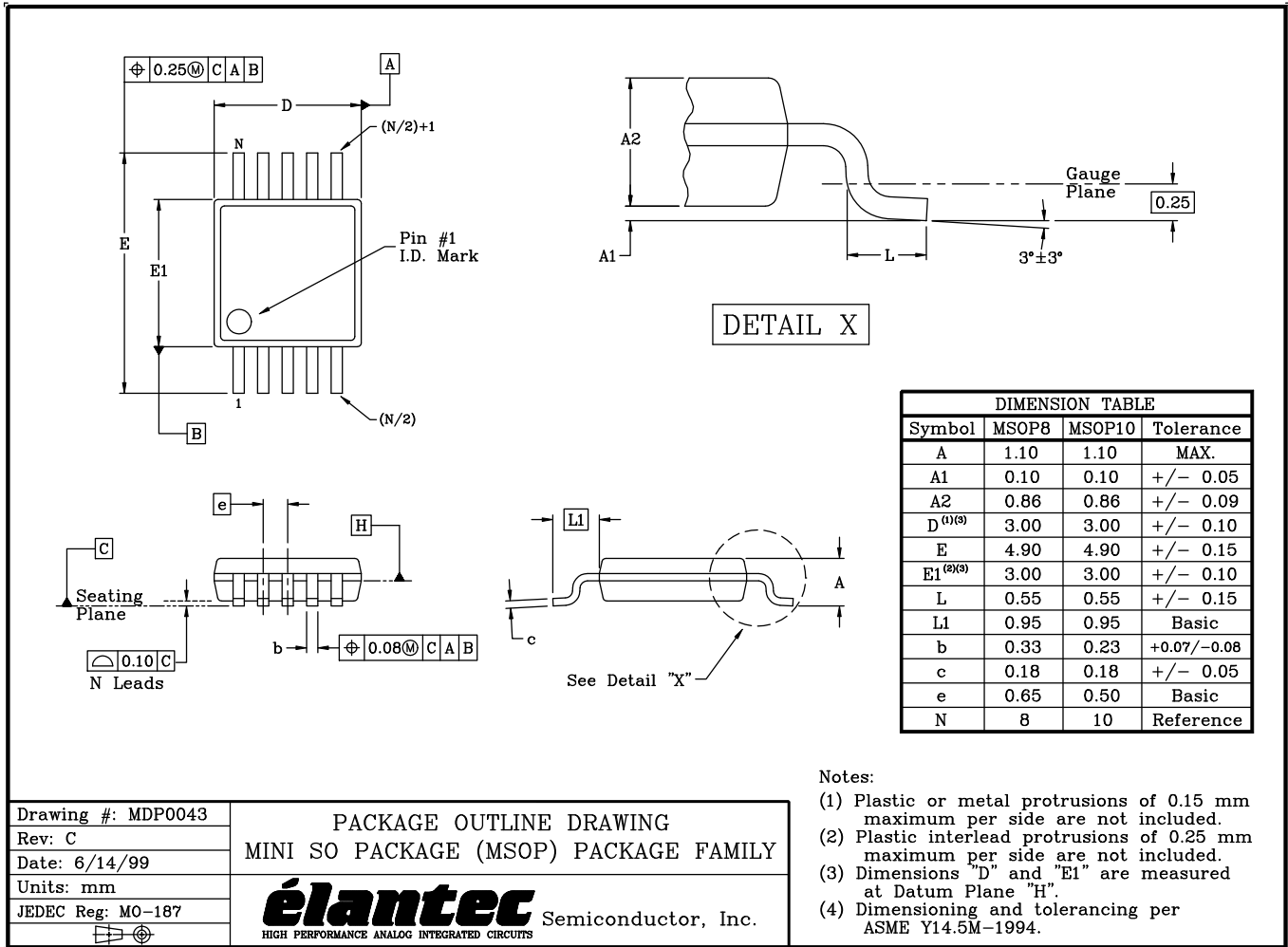

NOTE: The package drawing shown here may not be the latest version. To check the latest revision, please refer to the Intersil website at <http://www.intersil.com/design/packages/index.asp>

© Copyright Intersil Americas LLC 2002-2005. All Rights Reserved.  
 All trademarks and registered trademarks are the property of their respective owners.

For additional products, see [www.intersil.com/en/products.html](http://www.intersil.com/en/products.html)

Intersil products are manufactured, assembled and tested utilizing ISO9001 quality systems as noted in the quality certifications found at [www.intersil.com/en/support/qualandreliability.html](http://www.intersil.com/en/support/qualandreliability.html)

Intersil products are sold by description only. Intersil may modify the circuit design and/or specifications of products at any time without notice, provided that such modification does not, in Intersil's sole judgment, affect the form, fit or function of the product. Accordingly, the reader is cautioned to verify that datasheets are current before placing orders. Information furnished by Intersil is believed to be accurate and reliable. However, no responsibility is assumed by Intersil or its subsidiaries for its use; nor for any infringements of patents or other rights of third parties which may result from its use. No license is granted by implication or otherwise under any patent or patent rights of Intersil or its subsidiaries.

For information regarding Intersil Corporation and its products, see [www.intersil.com](http://www.intersil.com)