

ISL70001SRHEVAL1Z

Evaluation Board

AN1518

Rev.0.00

December 22, 2009

ISL70001SRHEVAL1Z Evaluation Board

The ISL70001SRHEVAL1Z evaluation board is designed to demonstrate the features of the ISL70001SRH, a TID and SEE hardened 6A synchronous buck regulator IC with integrated MOSFETs intended for Space applications. For more detailed information about the ISL70001SRH, please refer to the ISL70001SRH data sheet ([FN6947](#)).

The ISL70001SRHEVAL1Z evaluation board accepts a nominal 3V to 5.5V input voltage and provides a regulated output voltage ranging from 0.8V to 85% of the input voltage at output currents ranging from 0A to 6A. The output can be quickly set to any of six commonly used preset voltages (0.8V, 1.0V, 1.2V, 1.8V, 2.5V, 3.3V) or adjusted to an alternate voltage using the onboard potentiometer. A PGOOD (Power Good) signal goes high and lights a red LED to indicate that the output voltage is within a $\pm 11\%$ typical regulation window. A toggle switch is provided to conveniently enable or disable the output voltage.

The ISL70001SRHEVAL1Z evaluation board can be set to run from the nominal 1MHz internal oscillator of the ISL70001SRH or synchronized to a 1MHz $\pm 20\%$ external clock. Two or more ISL70001SRHEVAL1Z evaluation boards can be synchronized to each other in a Master/Slave configuration, with all Slave units switching 180° out-of-phase with respect to the Master unit.

Schematic and BOM

A schematic and BOM of the ISL70001SRHEVAL1Z evaluation board are shown in Figure 1 and Table 1, respectively. The schematic indicates numerous test points, which allow virtually all nodes of the evaluation circuit to be monitored directly. The BOM shows components that are representative of the types needed for a design, but these components are not space-qualified. Equivalent space-qualified components would be required for flight applications.

Recommended Test Equipment

- A 0V to 6V power supply with at least 10A source current capability.
- An electronic load capable of sinking current up to 6A.
- Two digital multimeters (DMMs).
- A 500MHz dual-trace oscilloscope.

Quick Start

1. Short J1, J2 (pins 2-3), J4 (pins 1-2), J5 and J15.
2. Open J3, J7 and J9-J13.
3. Toggle S2 to the down (OFF) position.
4. Turn on the power supply. Set the output voltage to 3.3V and set the output current limit to 10A. Turn off the power supply.
5. Connect the positive lead of the power supply to TP1 and the negative lead of the power supply to TP2.
6. Turn on the electronic load and set the output current to 3A.
7. Connect the positive lead of the electronic load to TP44 and connect the negative lead of the electronic load to TP45.
8. Configure one DMM to monitor the input voltage from TP22 to TP25.
9. Configure another DMM to monitor the output voltage from TP38 to TP39.
10. Connect Channel 1 of the oscilloscope to J6 (or from TP33 to TP28) to monitor the rectangular waveform on the LXx pins.
11. Connect Channel 2 of the oscilloscope to J14 (or from TP36 to TP37) to monitor the output voltage.
12. Toggle S2 to the up (ON) position.
13. Verify the output voltage is 0.8V $\pm 3\%$ and the frequency of the LXx waveform is 1MHz $\pm 10\%$.

Configuration Options

The ISL70001SRHEVAL1Z evaluation board can be easily configured for a number of different applications. Table 2 provides the available settings for the jumpers and toggle switch and explains their respective functions.

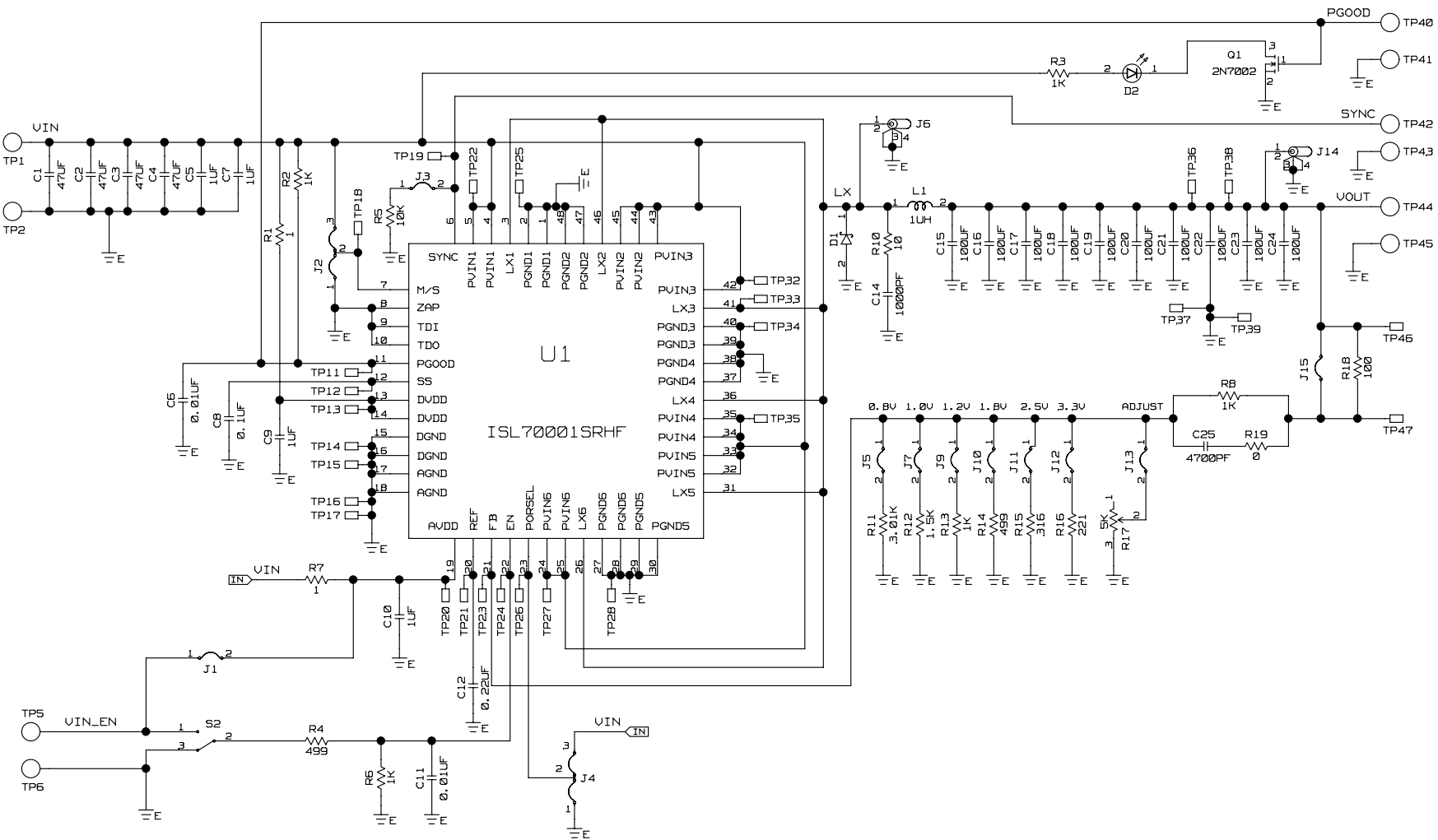

FIGURE 1. ISL70001SRHEVAL1Z SCHEMATIC

TABLE 1. ISL70001SRHEVAL1Z BOM

REF DES	QTY	PART NUMBER	VALUE	DESCRIPTION	MANUFACTURER
C1-C4	4		47 μ F	Capacitor, Ceramic, 10%, 10V, X7R, 1210	Various
C5, C7, C9, C10	4		1 μ F	Capacitor, Ceramic, 10%, 10V, X7R, 0603	Various
C6, C11	2		0.01 μ F	Capacitor, Ceramic, 10%, 16V X7R, 0603	Various
C8	1		0.1 μ F	Capacitor, Ceramic, 10%, 16V, X7R, 0603	Various
C12	1		0.22 μ F	Capacitor Ceramic, 10%, 16V, X7R, 0603	Various
C14	1		1000pF	Capacitor Ceramic, 10%, 16V, X7R, 0603	Various
C15-C24	10		100 μ F	Capacitor Ceramic, 20%, 6.3V, X5R, 1210	Various
C25	1		4700pF	Capacitor, Ceramic, 10%, 50V, X7R, 0603	Various
D1	1	MBRS320T3G-T		Diode, Schottky, 20V, 3A, SMC	On Semiconductor
D2	1	LTST-C170CKT		Diode, LED, Green	Vishay
J1, J3, J5, J7, J9-J13	9	69190-202HLF		Connector, Header, 1x2, Thru-hole	BERG/FCI
J2, J4	2	68000-236HLF-1X3		Connector, Header, 1x3, Thru-hole	BERG/FCI
J1-J5, J7, J9-J13, J15	12	SPC02SYAN		Connector, Jumper, 2-pin	Sullins
J6, J14	2	131-4353-00		Jack, Scope Probe, Thru-hole	Tektronics
L1	1	CDRH127/LDNP-1R0NC	1 μ H	Inductor, 30%, 14A, SMD	Sumida
Q1	1	2N7002-7-F-T		Transistor, MOSFET, N-channel, SOT-23	Diodes, Inc.
R1, R7	2		1 Ω	Resistor, Film, 1%, 1/10W, 0603	Various
R2, R3, R6, R8, R13	5		1k Ω	Resistor, Film, 1%, 1/10W, 0603	Various
R4, R14	2		499 Ω	Resistor, Film, 1%, 1/10W, 0603	Various
R5	1		10k Ω	Resistor, Film, 1%, 1/10W, 0603	Various
R10	1		10 Ω	Resistor, Film, 1%, 1/4W, 1206	Various
R11	1		3.01k Ω	Resistor, Film, 1%, 1/10W, 0603	Various
R12	1		1.5k Ω	Resistor, Film, 1%, 1/10W, 0603	Various
R15	1		316 Ω	Resistor, Film, 1%, 1/10W, 0603	Various
R16	1		221 Ω	Resistor, Film, 1%, 1/10W, 0603	Various
R17	1	3296W-1-502LF	5k Ω	Resistor, Potentiometer, Trim, 10%, 1/2W, Thru-hole	Bourns
R18	1		100 Ω	Resistor, Film, 1%, 1/10W, 0603	Various
R19	1		0 Ω	Resistor, Film, 1%, 1/10W, 0603	Various
S2	1	GT11MSCBE-T		Switch, Toggle, SPDT, SMD	ITT/C&K
TP1, TP2, TP5, TP6, TP40-45	10	1514-2		Terminal, Turret, Thru-hole	Keystone
TP11-TP28, TP32-TP39	26	5002		Connector, Test Point, Thru-hole	Various
U1	1	ISL70001SRHF		IC, Regulator, Switching, 6A, CQFP-48	Intersil
	1	SP2000-0.020-AC-1212-NA		Thermal Interface Material, Sil-Pad, 12inx12inx0.020in, with adhesive, cut to 0.4inx0.4in and place under U1	Bergquist

TABLE 2. CONFIGURATION OPTIONS

REF. DESIGNATOR	SETTING	FUNCTION
J1	Short	Selects AVDD to be monitored by the EN pin through a resistive divider (R4 and R6) if S2 is toggled to the down position.
	Open	Allows an external voltage connected to TP5 to be monitored by the EN pin through a resistive divider (R4 and R6) if S2 is toggled to the down position.
J2	Short 2-3	Selects Master mode, which forces the chip to run from the internal 1MHz oscillator. In Master mode, the SYNC pin is an output that provides a nominal 1MHz clock signal.
	Short 1-2	Selects Slave mode, which allows the chip to be synchronized to another ISL70001SRH or to an external clock. In Slave mode, the SYNC pin is an input that accepts a 1MHz synchronizing signal from the SYNC pin of another ISL70001SRH configured as a Master or from an external clock.
J3	Short	Loads the SYNC pin with R5, which is a 10kΩ resistor. If synchronization to an external clock over long distances is required, it may be necessary to use a controlled impedance trace to avoid excessive ringing on the SYNC line. If this is the case, the SYNC trace should be terminated into 50Ω at the Slave units. This can be accomplished by replacing R5 on the Slave units with a 50Ω resistor. Please note that the SYNC pin of an ISL70001SRH is not designed to drive a 50Ω load.
	Open	Disconnects the SYNC pin from R5.
J4	Short 2-3	Selects the 5V input UVLO threshold. Use this setting when the nominal input voltage is 5V.
	Short 1-2	Selects the 3.3V input UVLO threshold. Use this setting when the nominal input voltage is 3.3V. Also use this setting for nominal input voltages between 5V and 3.3V.
J5	Short	Selects the 0.8V preset output voltage option as long as J7 and J9-J13 are open.
	Open	Allows output voltages other than 0.8V to be selected.
J7	Short	Selects the 1.0V preset output voltage option as long as J5 and J9-J13 are open.
	Open	Allows output voltages other than 1.0V to be selected.
J9	Short	Selects the 1.2V preset output voltage option as long as J5, J7 and J10-J13 are open.
	Open	Allows output voltages other than 1.2V to be selected.
J10	Short	Selects the 1.8V preset output voltage option as long as J5, J7, J9 and J11-J13 are open.
	Open	Allows output voltages other than 1.8V to be selected.
J11	Short	Selects the 2.5V preset output voltage option as long as J5, J7, J9-J10 and J12-J13 are open.
	Open	Allows output voltages other than 2.5V to be selected.
J12	Short	Selects the 3.3V preset output voltage option as long as J5, J7, J9-J11 and J13 are open.
	Open	Allows output voltages other than 3.3V to be selected.
J13	Short	Selects the adjustable output voltage option as long as J5, J7 and J9-J12 are open. Potentiometer, R17, can be used to adjust the output voltage.
	Open	Allows the preset output voltage options to be selected.
J15	Short	Shorts out R18, allowing normal operation of the evaluation board.
	Open	Facilitates control loop stability measurements by allowing a signal to be injected across R18.
S2	Short 2-3	S1 in the up position shorts contacts 2-3. This pulls the EN pin low to disable the output voltage.
	Short 1-2	S1 in the down position shorts contacts 1-2. This enables the output voltage as long as the voltage on the EN pin exceeds 0.6V.

Layout Guidelines

1. Use a four layer PCB with 2 ounce copper.
2. Layer 2 should be a dedicated ground plane and layer 3 should be a dedicated power plane split between VIN and VOUT.
3. Layers 1 and 4 should be used primarily for signals, but can also be used to increase the VIN, VOUT and ground planes as required.
4. Connect all AGND, DGND and PGNDx pins directly to the ground plane. Connect all PVINx pins directly to the VIN portion of the power plane.
5. Locate ceramic bypass capacitors as close as possible to U1. Prioritize the placement of the bypass capacitors on the pins of U1 in the order shown: REF, SS, AVDD, DVDD, PVINx (C5, C7), EN, PGOOD, PVINx (C1-C4).
6. Locate the output voltage resistive divider as close as possible to the FB pin of the IC. The top leg of the divider should connect directly to the POL (Point Of Load) and the bottom leg of the resistive divider should connect directly to AGND. The junction of the resistive divider should connect directly to the FB pin.
7. Locate the Schottky diode, D1, as close as possible to the LXx and PGNDx pins of the IC. A smaller Schottky diode may be used as long as derating requirements are satisfied.
8. Use a small island of copper to connect the LXx pins of U1 to the inductor, L1, on layers 1 and 4. Void the copper on layers 2 and 3 adjacent to the island to minimize capacitive coupling. Place most of the island on layer 4 to minimize the amount of copper that must be voided from the ground layer (layer 2).
9. Keep all signal traces as short as possible.
10. A small series snubber (R10 and C14) connected from the LXx pins to the PGNDx pins may be used to damp ringing on the LXx pins if desired.
11. For optimum thermal performance, place a pattern of vias on the top layer of the PCB directly underneath U1. Connect the vias to the ground plane (layer 2), which serves as a heatsink. Thermal interface material such as a Sil-Pad should be used to fill the gap between the vias and the bottom of U1 to insure good thermal contact. Using a Sil-Pad has the added benefit of raising the bottom of U1 from the PCB surface so that a slight bend can be added to the leads for strain relief.
12. Refer to Figures 2 through 7 for an example layout.

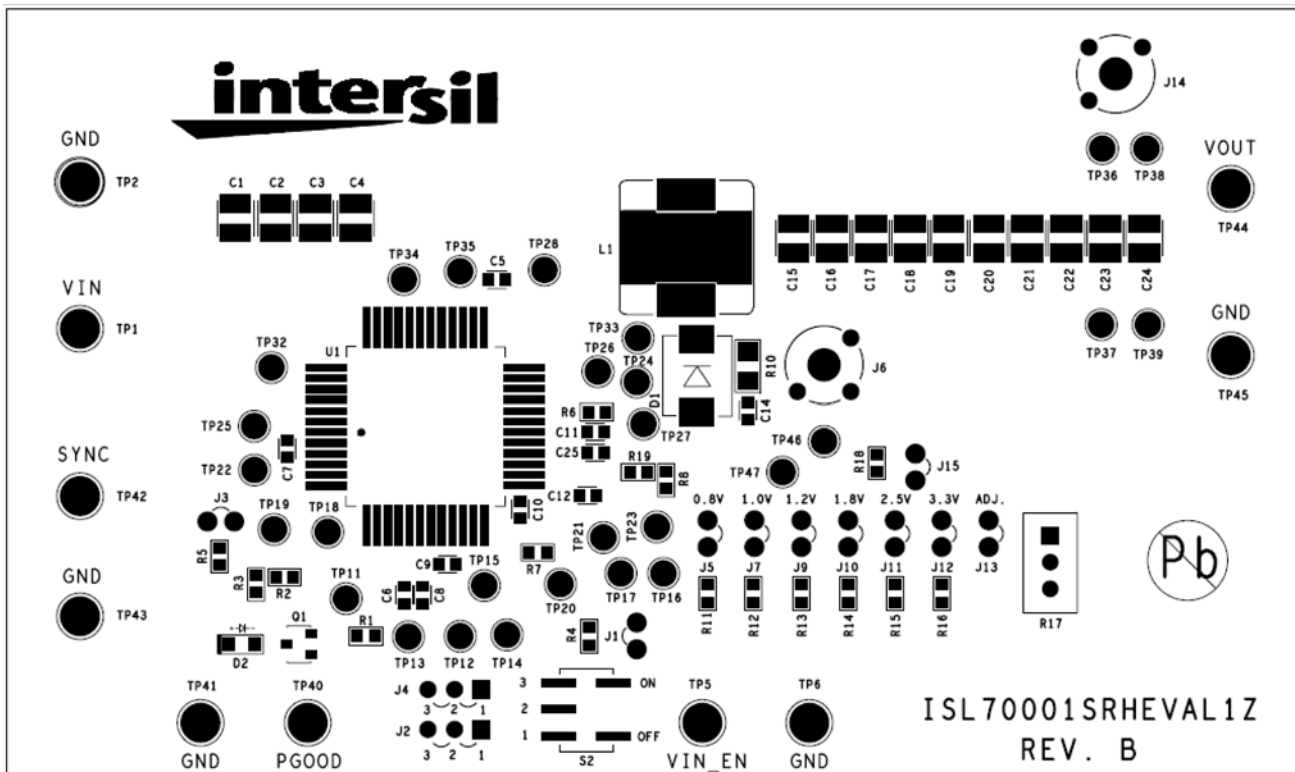

FIGURE 2. SILK SCREEN TOP

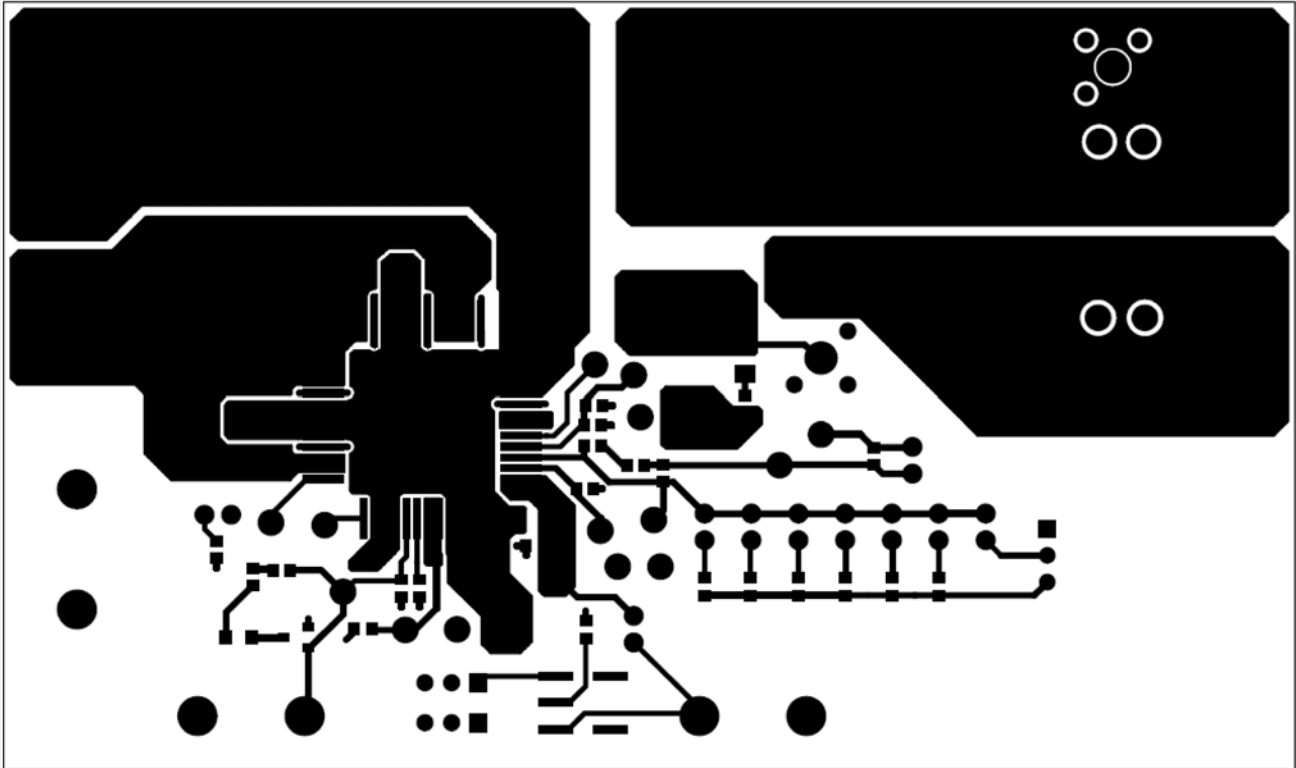

FIGURE 3. FIRST LAYER ETCH

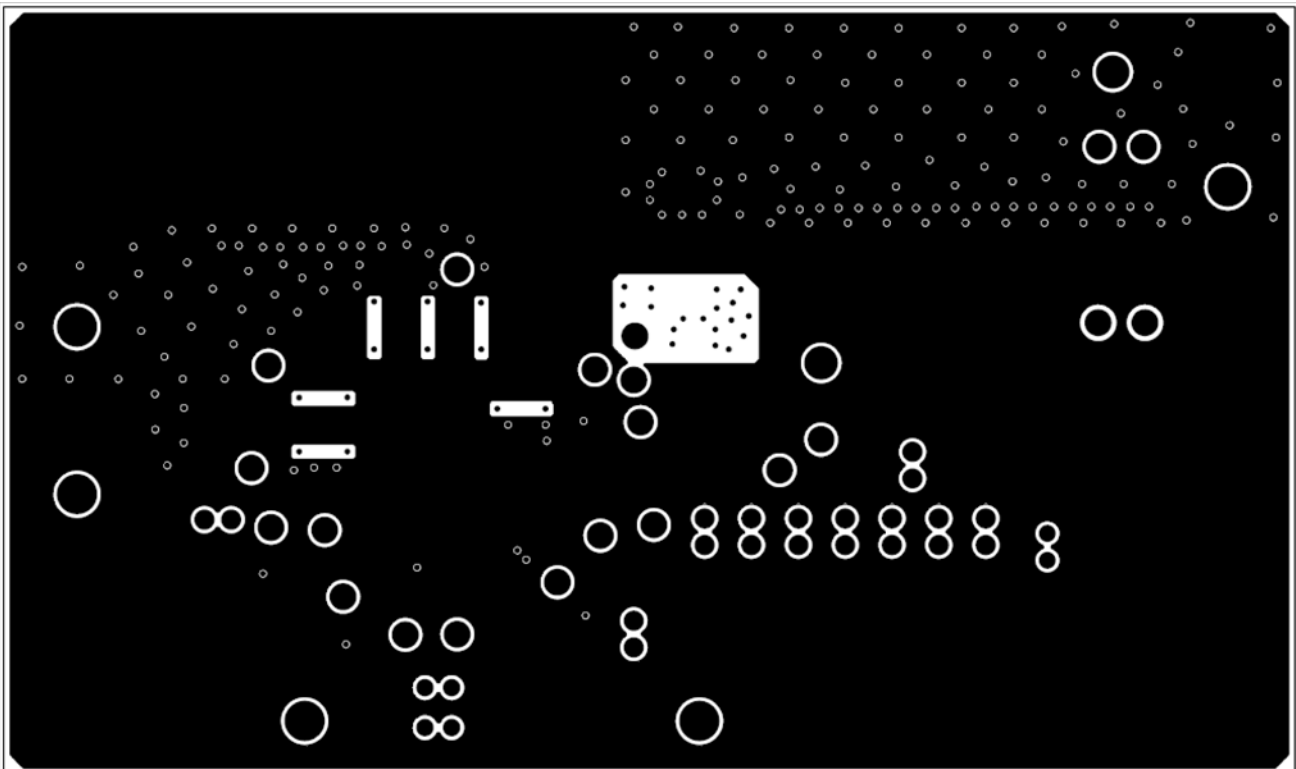

FIGURE 4. SECOND LAYER ETCH

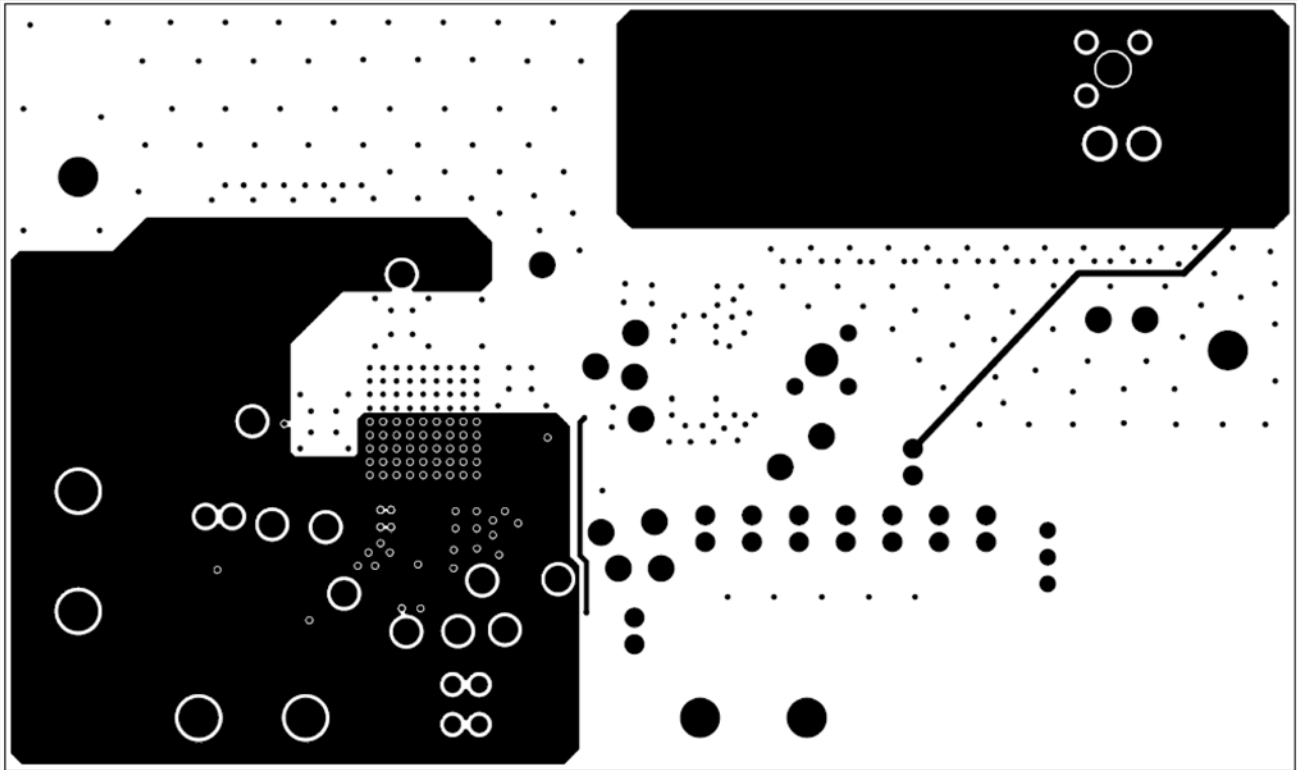

FIGURE 5. THIRD LAYER ETCH

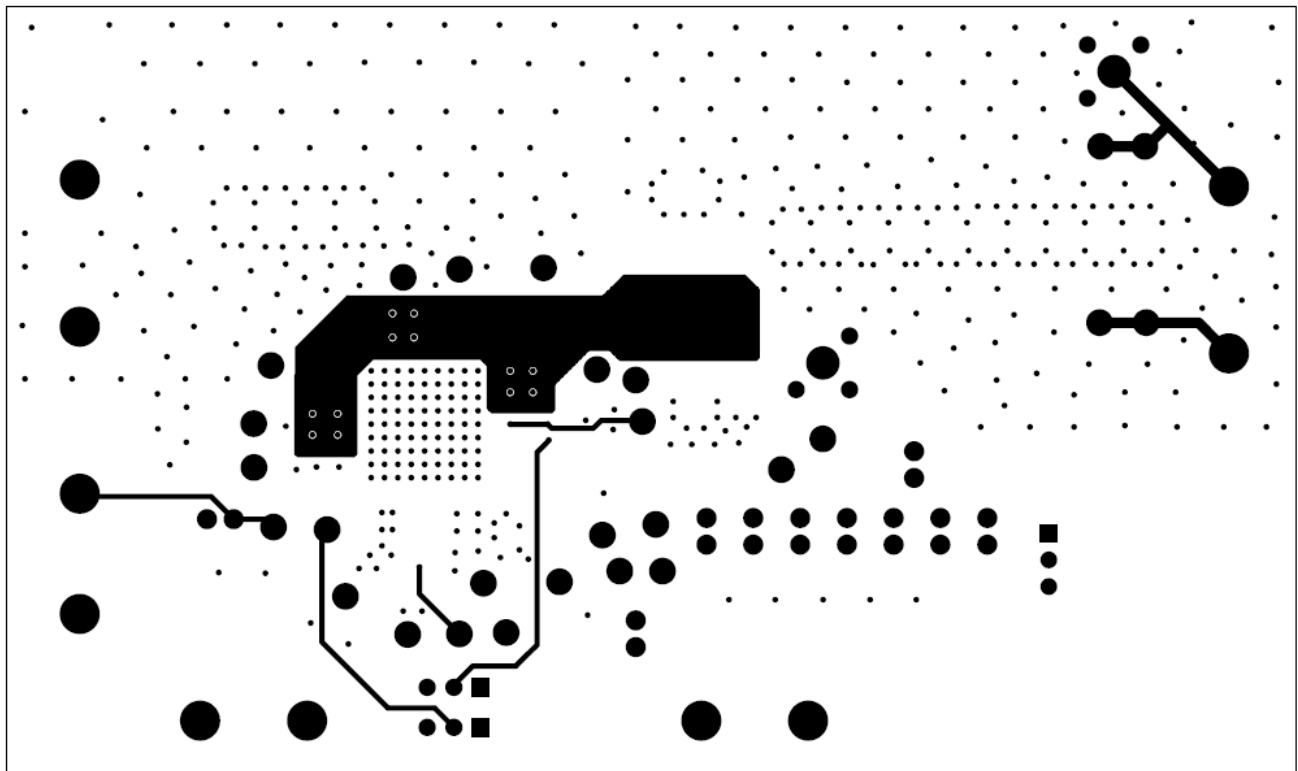

FIGURE 6. FOURTH LAYER ETCH

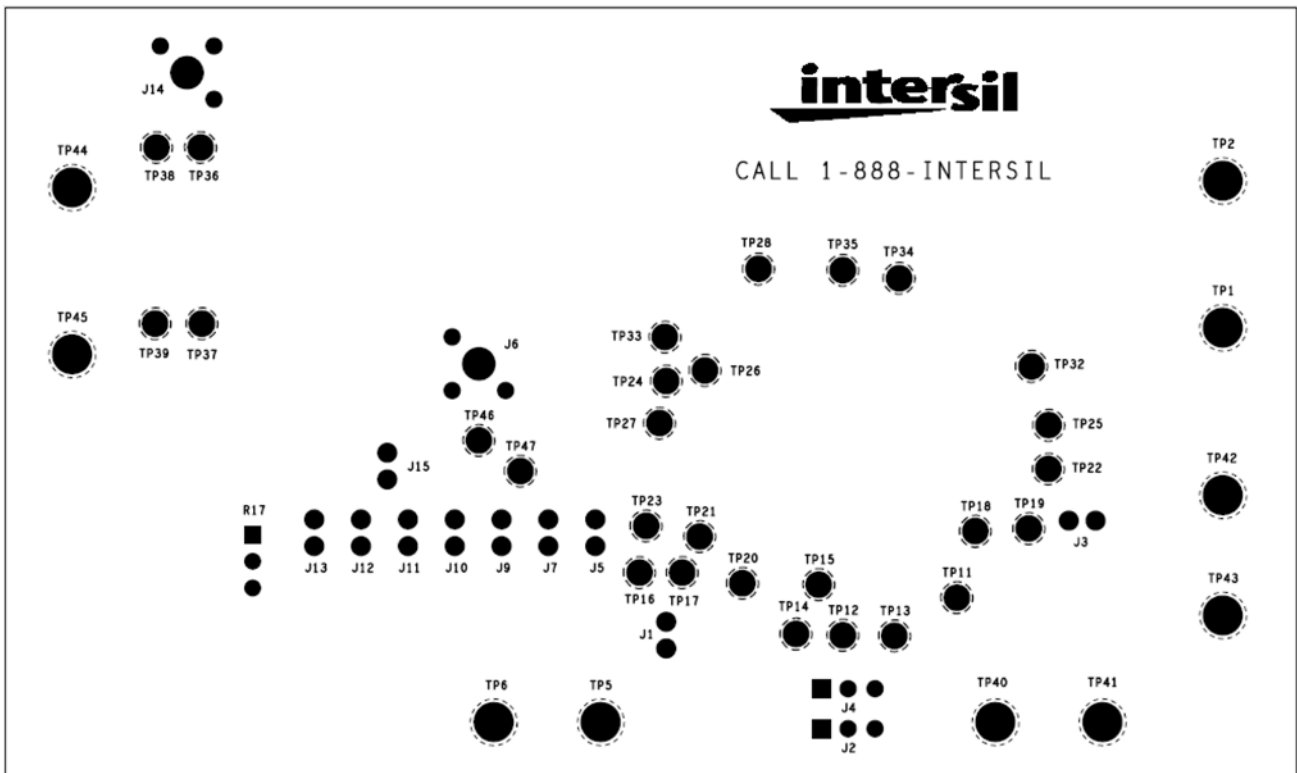

FIGURE 7. SILK SCREEN BOTTOM

Notice

1. Descriptions of circuits, software and other related information in this document are provided only to illustrate the operation of semiconductor products and application examples. You are fully responsible for the incorporation or any other use of the circuits, software, and information in the design of your product or system. Renesas Electronics disclaims any and all liability for any losses and damages incurred by you or third parties arising from the use of these circuits, software, or information.
2. Renesas Electronics hereby expressly disclaims any warranties against and liability for infringement or any other claims involving patents, copyrights, or other intellectual property rights of third parties, by or arising from the use of Renesas Electronics products or technical information described in this document, including but not limited to, the product data, drawings, charts, programs, algorithms, and application examples.
3. No license, express, implied or otherwise, is granted hereby under any patents, copyrights or other intellectual property rights of Renesas Electronics or others.
4. You shall not alter, modify, copy, or reverse engineer any Renesas Electronics product, whether in whole or in part. Renesas Electronics disclaims any and all liability for any losses or damages incurred by you or third parties arising from such alteration, modification, copying or reverse engineering.
5. Renesas Electronics products are classified according to the following two quality grades: "Standard" and "High Quality". The intended applications for each Renesas Electronics product depends on the product's quality grade, as indicated below.
"Standard": Computers; office equipment; communications equipment; test and measurement equipment; audio and visual equipment; home electronic appliances; machine tools; personal electronic equipment; industrial robots; etc.
"High Quality": Transportation equipment (automobiles, trains, ships, etc.); traffic control (traffic lights); large-scale communication equipment; key financial terminal systems; safety control equipment; etc.
Unless expressly designated as a high reliability product or a product for harsh environments in a Renesas Electronics data sheet or other Renesas Electronics document, Renesas Electronics products are not intended or authorized for use in products or systems that may pose a direct threat to human life or bodily injury (artificial life support devices or systems; surgical implantations; etc.), or may cause serious property damage (space system; undersea repeaters; nuclear power control systems; aircraft control systems; key plant systems; military equipment; etc.). Renesas Electronics disclaims any and all liability for any damages or losses incurred by you or any third parties arising from the use of any Renesas Electronics product that is inconsistent with any Renesas Electronics data sheet, user's manual or other Renesas Electronics document.
6. When using Renesas Electronics products, refer to the latest product information (data sheets, user's manuals, application notes, "General Notes for Handling and Using Semiconductor Devices" in the reliability handbook, etc.), and ensure that usage conditions are within the ranges specified by Renesas Electronics with respect to maximum ratings, operating power supply voltage range, heat dissipation characteristics, installation, etc. Renesas Electronics disclaims any and all liability for any malfunctions, failure or accident arising out of the use of Renesas Electronics products outside of such specified ranges.
7. Although Renesas Electronics endeavors to improve the quality and reliability of Renesas Electronics products, semiconductor products have specific characteristics, such as the occurrence of failure at a certain rate and malfunctions under certain use conditions. Unless designated as a high reliability product or a product for harsh environments in a Renesas Electronics data sheet or other Renesas Electronics document, Renesas Electronics products are not subject to radiation resistance design. You are responsible for implementing safety measures to guard against the possibility of bodily injury, injury or damage caused by fire, and/or danger to the public in the event of a failure or malfunction of Renesas Electronics products, such as safety design for hardware and software, including but not limited to redundancy, fire control and malfunction prevention, appropriate treatment for aging degradation or any other appropriate measures. Because the evaluation of microcomputer software alone is very difficult and impractical, you are responsible for evaluating the safety of the final products or systems manufactured by you.
8. Please contact a Renesas Electronics sales office for details as to environmental matters such as the environmental compatibility of each Renesas Electronics product. You are responsible for carefully and sufficiently investigating applicable laws and regulations that regulate the inclusion or use of controlled substances, including without limitation, the EU RoHS Directive, and using Renesas Electronics products in compliance with all these applicable laws and regulations. Renesas Electronics disclaims any and all liability for damages or losses occurring as a result of your noncompliance with applicable laws and regulations.
9. Renesas Electronics products and technologies shall not be used for or incorporated into any products or systems whose manufacture, use, or sale is prohibited under any applicable domestic or foreign laws or regulations. You shall comply with any applicable export control laws and regulations promulgated and administered by the governments of any countries asserting jurisdiction over the parties or transactions.
10. It is the responsibility of the buyer or distributor of Renesas Electronics products, or any other party who distributes, disposes of, or otherwise sells or transfers the product to a third party, to notify such third party in advance of the contents and conditions set forth in this document.
11. This document shall not be reprinted, reproduced or duplicated in any form, in whole or in part, without prior written consent of Renesas Electronics.
12. Please contact a Renesas Electronics sales office if you have any questions regarding the information contained in this document or Renesas Electronics products.
(Note 1) "Renesas Electronics" as used in this document means Renesas Electronics Corporation and also includes its directly or indirectly controlled subsidiaries.
(Note 2) "Renesas Electronics product(s)" means any product developed or manufactured by or for Renesas Electronics.

(Rev.4.0-1 November 2017)



SALES OFFICES

Renesas Electronics Corporation

<http://www.renesas.com>

Refer to "<http://www.renesas.com/>" for the latest and detailed information.

Renesas Electronics America Inc.
1001 Murphy Ranch Road, Milpitas, CA 95035, U.S.A.
Tel: +1-408-432-8888, Fax: +1-408-434-5351

Renesas Electronics Canada Limited
9251 Yonge Street, Suite 8309 Richmond Hill, Ontario Canada L4C 9T3
Tel: +1-905-237-2004

Renesas Electronics Europe Limited
Dukes Meadow, Millboard Road, Bourne End, Buckinghamshire, SL8 5FH, U.K
Tel: +44-1628-651-700, Fax: +44-1628-651-804

Renesas Electronics Europe GmbH
Arcadiastrasse 10, 40472 Düsseldorf, Germany
Tel: +49-211-6503-0, Fax: +49-211-6503-1327

Renesas Electronics (China) Co., Ltd.
Room 1709 Quantum Plaza, No.27 ZhichunLu, Haidian District, Beijing, 100191 P. R. China
Tel: +86-10-8235-1155, Fax: +86-10-8235-7679

Renesas Electronics (Shanghai) Co., Ltd.
Unit 301, Tower A, Central Towers, 555 Langao Road, Putuo District, Shanghai, 200333 P. R. China
Tel: +86-21-2226-0888, Fax: +86-21-2226-0999

Renesas Electronics Hong Kong Limited
Unit 1601-1611, 16/F., Tower 2, Grand Century Place, 193 Prince Edward Road West, Mongkok, Kowloon, Hong Kong
Tel: +852-2265-6688, Fax: +852-2886-9022

Renesas Electronics Taiwan Co., Ltd.
13F, No. 363, Fu Shing North Road, Taipei 10543, Taiwan
Tel: +886-2-8175-9600, Fax: +886-2-8175-9670

Renesas Electronics Singapore Pte. Ltd.
80 Bendemeer Road, Unit #06-02 Hyflux Innovation Centre, Singapore 339949
Tel: +65-6213-0200, Fax: +65-6213-0300

Renesas Electronics Malaysia Sdn.Bhd.
Unit 1207, Block B, Menara Amcorp, Amcorp Trade Centre, No. 18, Jln Persiaran Barat, 46050 Petaling Jaya, Selangor Darul Ehsan, Malaysia
Tel: +60-3-7955-9390, Fax: +60-3-7955-9510

Renesas Electronics India Pvt. Ltd.
No.777C, 100 Feet Road, HAL 2nd Stage, Indiranagar, Bangalore 560 038, India
Tel: +91-80-67208700, Fax: +91-80-67208777

Renesas Electronics Korea Co., Ltd.
17F, KAMCO Yangjae Tower, 262, Gangnam-daero, Gangnam-gu, Seoul, 06265 Korea
Tel: +82-2-558-3737, Fax: +82-2-558-5338